

INSTALLATION INSTRUCTIONS

PEUGEOT 3008 5 DOOR

PEU-3008-5-A

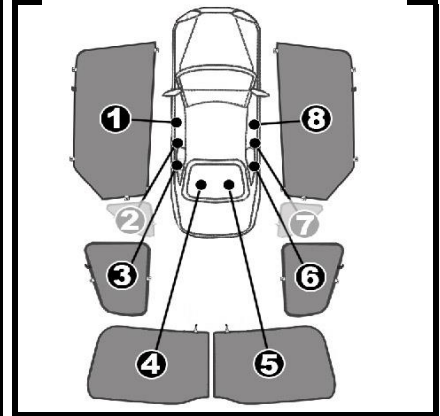

COMPONENTS INCLUDED

SHADES

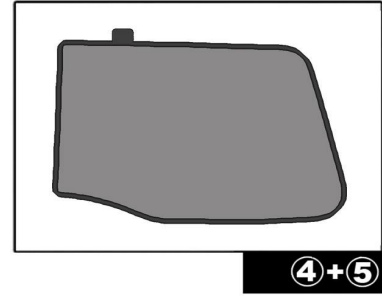
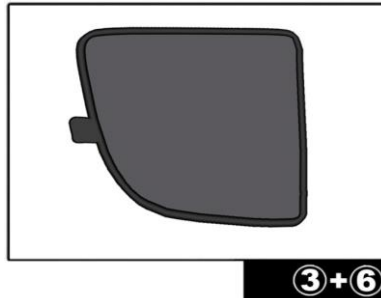
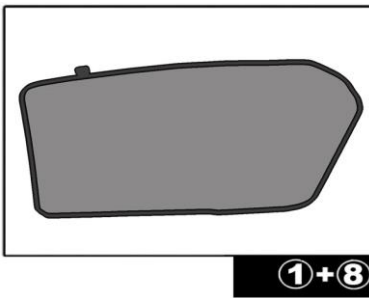

FIXING CLIPS



CL-M02 x8



CL-M011 x4

SIDE SHADE INSTALLATION

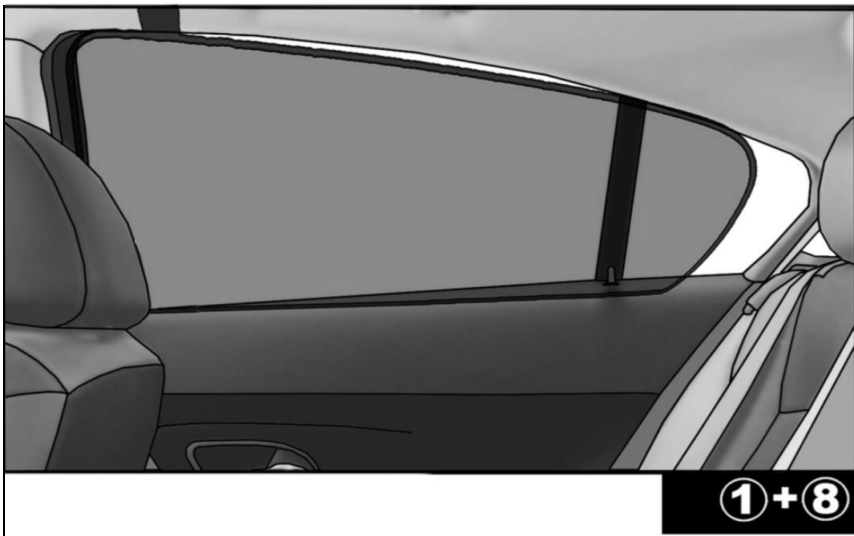
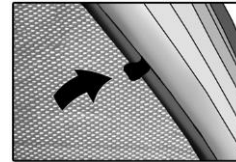
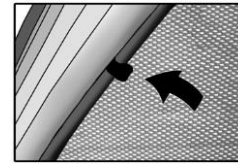
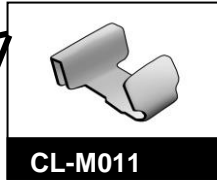
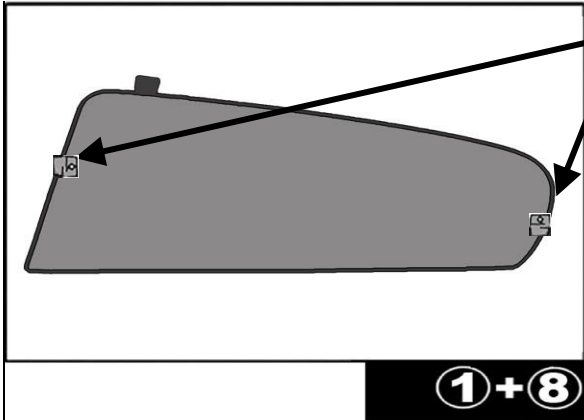

QUARTER LIGHT SHADE INSTALLATION

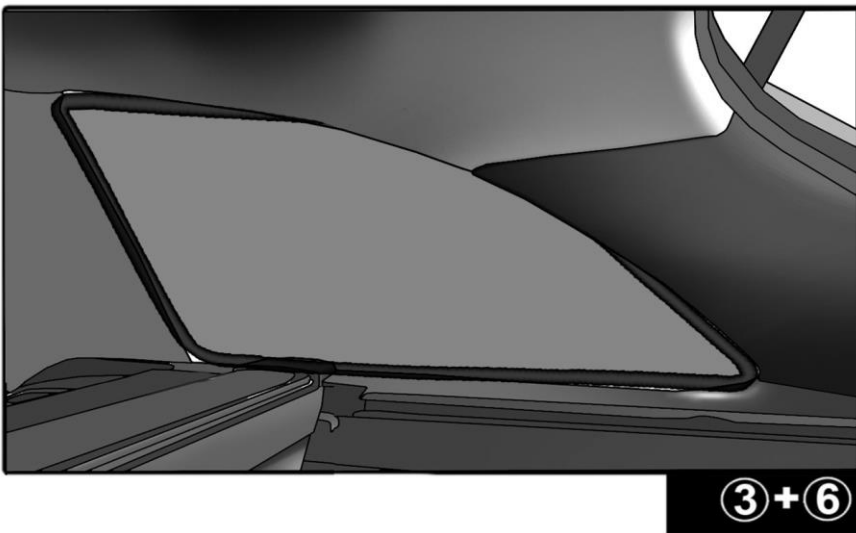
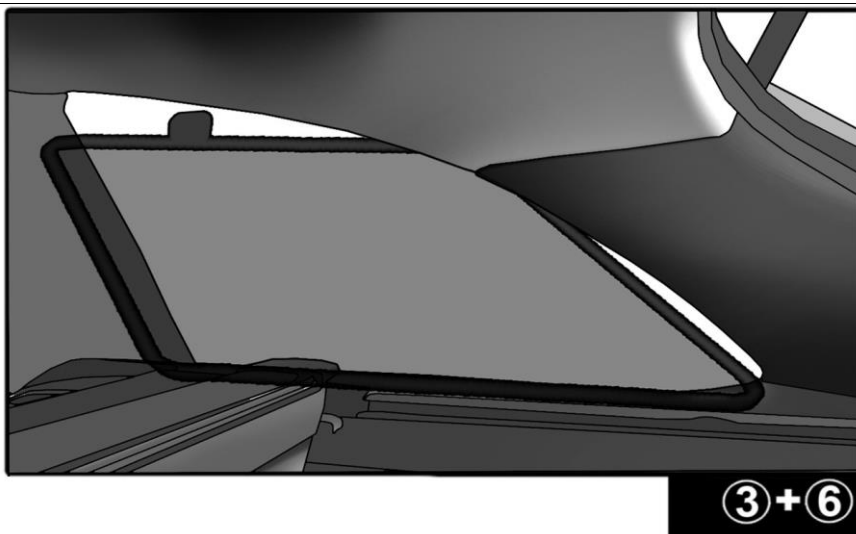
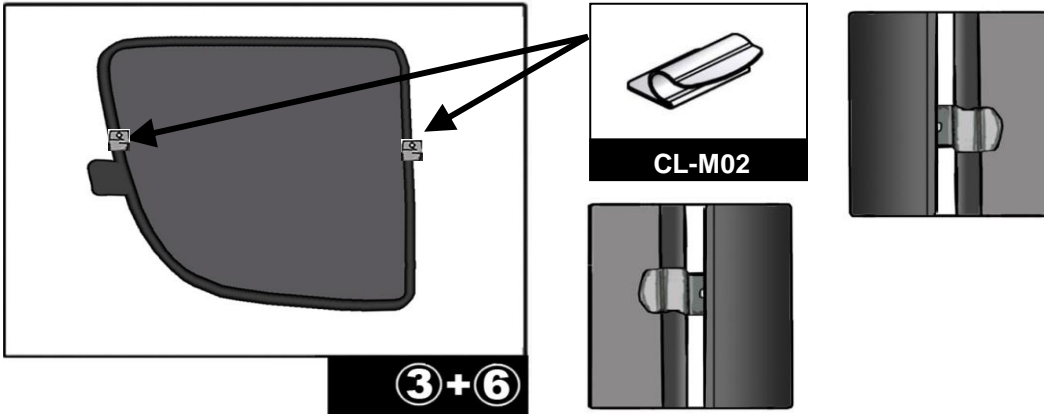

REAR SHADE INSTALLATION

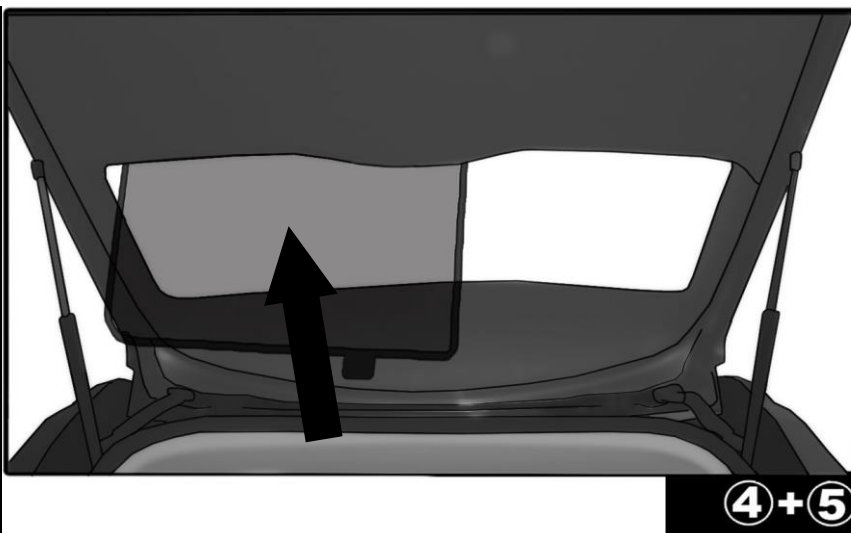
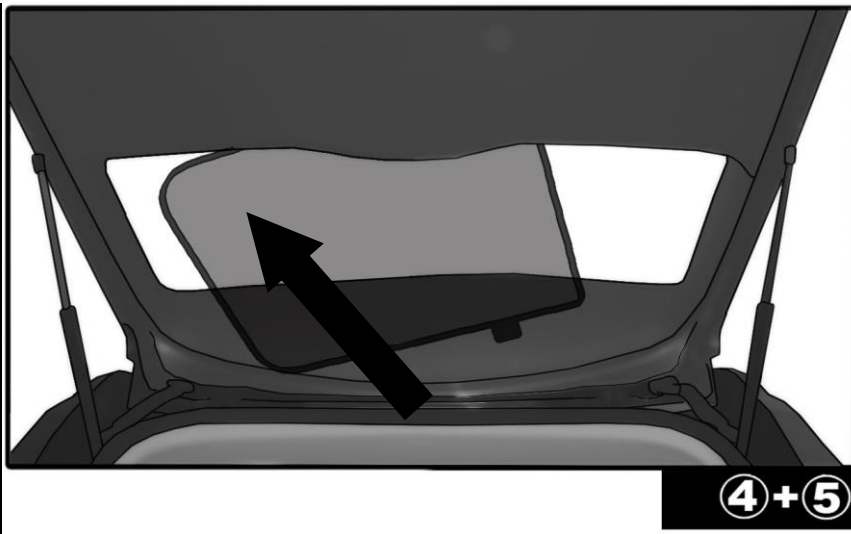
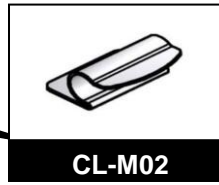
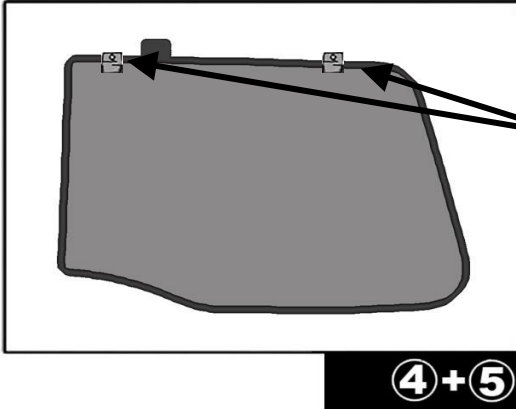

REAR SHADE INSTALLATION

